

Single Section Wall Mount Cabinet

Single/One Section Wall Mount Cabinet

- Top with Fan.
- Side door quick open
- With Earth Kit
- Thickness of Steel: Rail 1.5mm, others 1.2mm

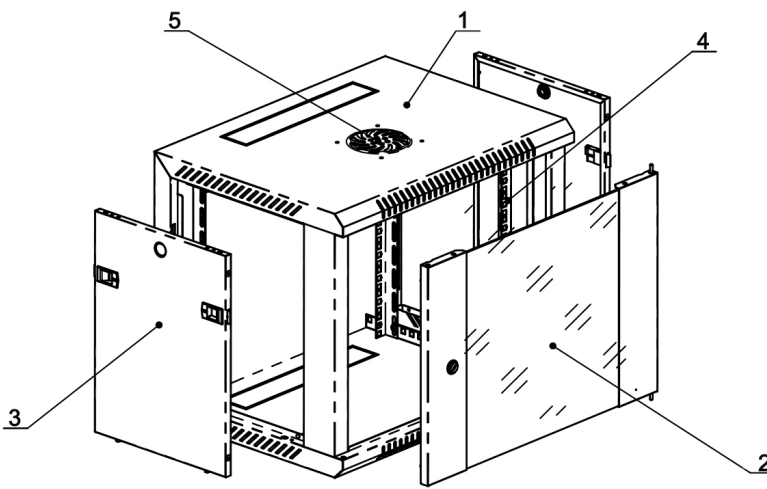

No.	Item	Qty
1	Weld Frame (Body)	1
2	Front Glass Door	1
3	Side Panel	2
4	Mounting Element	4
5	Fan	-

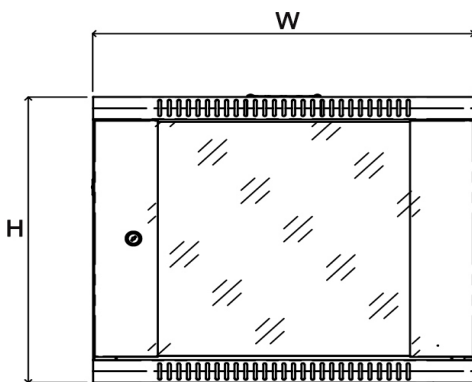

Front View

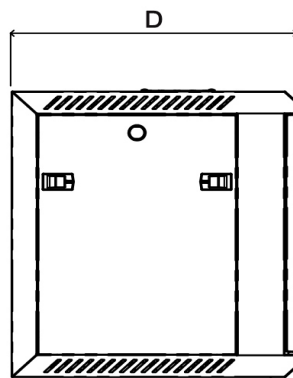

Side View

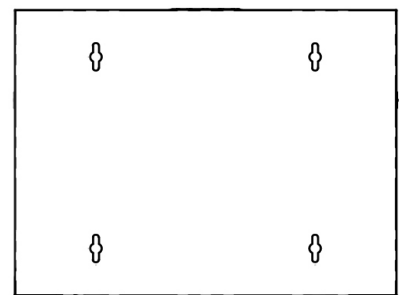

Back View

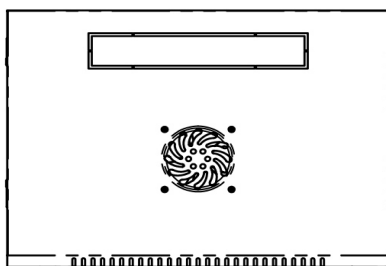

Top View

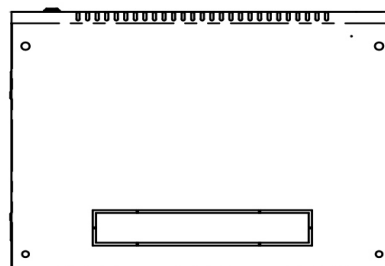

Bottom View

PRODUCTS DETAILS

G.B P/N	MODEL NO.	CAPACITY	WIDTH (MM)	DEPTH (MM)	HEIGHT (MM)
67970002091	TN-007-6406	6U	600	400	368
67970002111	TN-007-6606		600	600	
67970002891	TN-007-5410	10U	540	400	546
67970010091	TN-007-6510		600	500	
67970010491	TN-007-6610		600	600	
67970010891	TN-007-6515	15U	600	500	769
67970011291	TN-007-6615		600	600	
67970012091	TN-007-6520	20U	600	500	990
67970012491	TN-007-6620		600	600	
67970013291	TN-007-6625	25U	600	500	1215

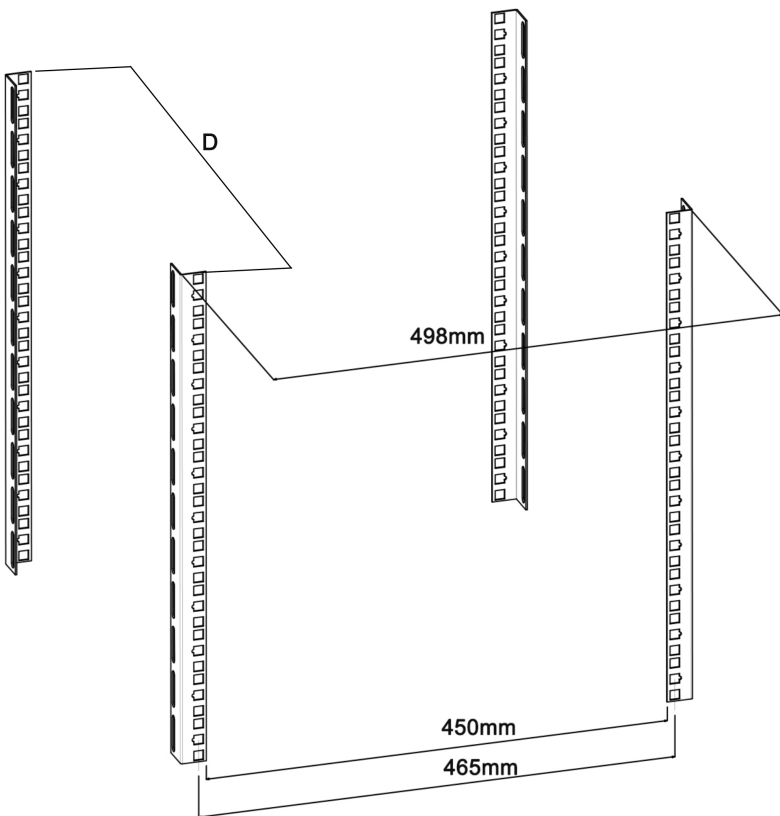

Suitable for all 19" Equipment

- 400mm Depth Cabinet can install Max Depth Equipment is 340mm Depth.
- 500mm Depth Cabinet can install Max Depth Equipment is 440mm Depth
- 600mm Depth Cabinet can Install Max Depth Equipment is 540mm Depth